

TGM1NE Series Moulded Case Circuit Breaker

- 1 Body
- 2 Mechanical interlock of mechanism (optional to customers)
- 3 Phase partition (standard)
- 4 Plug-in type (optional to customers)
- 5 Undervoltage release (optional to customers)
- 6 Shunt release (optional to customers)
- 7 Alarm contact (optional to customers)
- 8 Aux. contact (optional to customers)
- 9 Rotating handle operating mechanism (optional to customers)
- 10 Electric motor operating mechanism (optional to customers)
- 11 Front panel connection transition plate (optional to customers)
- 12 Rear panel connection transition plate (optional to customers)

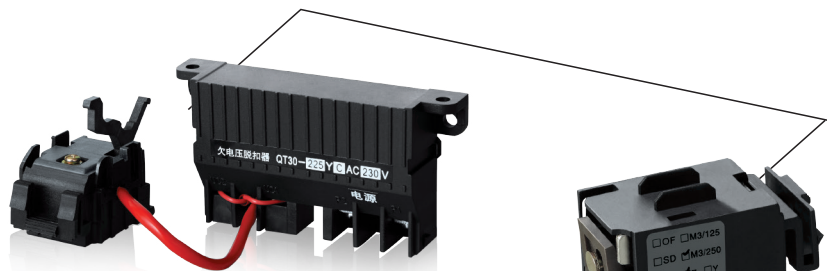

5



6



9



10



2



3



4



1



7

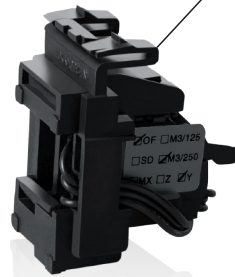

8

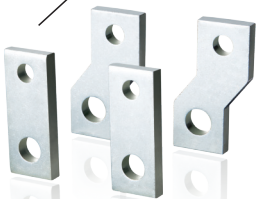

11



12

TGM1NE Series Moulded Case Circuit Breaker

Release type and accessory code

Table 1



Accessory name	Accessory code
	Electronic release
No accessory	300
Alarm contact	308
Shunt release	310
Aux. contact	320
Undervoltage release	330
Shunt release, Aux. contact	340
Shunt release, Undervoltage release	350
Two sets of Aux. contacts	360
Aux. contacts, Undervoltage release	370
Shunt release, Alarm contact	318
Aux. contact, Alarm contact	328
Undervoltage release, Alarm contact	338
Shunt release, Aux. contact, Alarm contact	348
Two sets of aux. contacts, alarm contact	368
Aux. contact, Undervoltage release, Alarm contact	378

Code of N-Pole

Table 2

Code	Description
A	No overcurrent release element is mounted on the N-pole, and the N-pole is normally on.
B	No overcurrent release element is mounted on the N-pole, and the N-pole is open and closed together with other three poles (the pole N is closed prior to open)
C	An overcurrent release element is mounted on the N-pole, and the N-pole is open and closed together with other three poles (the pole N is closed prior to open)
D	An overcurrent release element is mounted on the N-pole, and the N-pole is normally on.

Note: No code for 3-pole product; 3N corresponds to A type or D type; 4P corresponds to B type or C type.

TGM1NE Series Moulded Case Circuit Breaker

3 Technical Parameters

3.1 Main technical parameters

Table 3

Basic parameters																	
Frame current I _{nm} (A)	100		125			160			250			320			400		
Number of poles	3P, 3P+N, 4P																
Frequency (Hz)	50/60																
Rated working voltage U _e (V)	380/400/415 500/550 660/690																
Rated insulation voltage U _i (V)	1000																
Rated impulse withstand voltage U _{imp} (kV)	8														12		
Rated current range I _n (A)	32AF:12.5-32 63AF:25-63 100AF:40-100			32AF:12.5-32 63AF:25-63 125AF:50-125			63AF:25-63 125AF:50-125 160AF:63-160			200AF:80-200 250AF:100-250		200AF:80-200 250AF:100-250 320AF:125-320		300AF:120-300 315AF:125-315 400AF:160-400			
Breaking capacity grade	L	M	H	L	M	H	L	M	H	M	H	M	H	M	H		
Rated limit short-circuit breaking capacity I _{cu} (kA)	AC415V	36	50	85	36	50	85	36	50	85	50	85	50	85	70	100	
	AC550V	10	30	40	10	30	40	10	30	40	30	40	30	40	40	50	
	AC690V	8	10	20	8	10	20	8	10	20	10	20	10	20	20	30	
Rated operating short-circuit breaking capacity I _{cs} (kA)	AC415V	36	50	50	36	50	50	36	50	50	50	50	50	50	70	70	
	AC550V	10	30	40	10	30	40	10	30	40	30	40	30	40	30	40	
	AC690V	5	10	10	5	10	10	5	10	10	10	10	10	10	20	20	
I _{ew} (kA/1s)	AC415V	2		2			2.5			3		4		6			
Isolation function	Yes (for 3P and 4P); No (for 3P+N)																
Flashover distance (mm)	≤50														≤100		
Mechanical life(times)	Without maintenance	20,000		20,000			20,000			20,000		20,000		10,000			
	With maintenance	40,000		40,000			40,000			40,000		40,000		20,000			
Electrical life(times)	10,000		10,000			10,000			10,000		10,000		10,000		8,000		
Protection function information																	
Overload long-time delay protection	■ (Standard)		■ (Standard)			■ (Standard)			■ (Standard)		■ (Standard)		■ (Standard)		■ (Standard)		
Short-circuit short-time delay protection	■ (Standard)		■ (Standard)			■ (Standard)			■ (Standard)		■ (Standard)		■ (Standard)		■ (Standard)		
Short-circuit instantaneous protection	■ (Standard)		■ (Standard)			■ (Standard)			■ (Standard)		■ (Standard)		■ (Standard)		■ (Standard)		
Grounding protection	□ (Optional)		□ (Optional)			□ (Optional)			□ (Optional)		□ (Optional)		□ (Optional)		□ (Optional)		
Neutral pole protection	□ (Optional)		□ (Optional)			□ (Optional)			□ (Optional)		□ (Optional)		□ (Optional)		□ (Optional)		
Other function information																	
Communication module (electronic shunt alarm accessory)	□ (Optional)		□ (Optional)			□ (Optional)			□ (Optional)		□ (Optional)		□ (Optional)		□ (Optional)		
Overload alarm non-trip	□ (Optional)		□ (Optional)			□ (Optional)			□ (Optional)		□ (Optional)		□ (Optional)		□ (Optional)		
Operation LED indicator	■ (Standard)		■ (Standard)			■ (Standard)			■ (Standard)		■ (Standard)		■ (Standard)		■ (Standard)		
Pre-alarm LED indicator	■ (Standard)		■ (Standard)			■ (Standard)			■ (Standard)		■ (Standard)		■ (Standard)		■ (Standard)		
Alarm LED indicator	■ (Standard)		■ (Standard)			■ (Standard)			■ (Standard)		■ (Standard)		■ (Standard)		■ (Standard)		
Accessory information																	
Direct operation by handle	■ (Standard)		■ (Standard)			■ (Standard)			■ (Standard)		■ (Standard)		■ (Standard)		■ (Standard)		
USB data cable	□ (Optional)		□ (Optional)			□ (Optional)			□ (Optional)		□ (Optional)		□ (Optional)		□ (Optional)		
Extended rotating handle	□ (Optional)		□ (Optional)			□ (Optional)			□ (Optional)		□ (Optional)		□ (Optional)		□ (Optional)		
Electric motor operating mechanism	□ (Optional)		□ (Optional)			□ (Optional)			□ (Optional)		□ (Optional)		□ (Optional)		□ (Optional)		
Shunt release	□ (Optional)		□ (Optional)			□ (Optional)			□ (Optional)		□ (Optional)		□ (Optional)		□ (Optional)		
Undervoltage release	□ (Optional)		□ (Optional)			□ (Optional)			□ (Optional)		□ (Optional)		□ (Optional)		□ (Optional)		
Aux. contact	□ (Optional)		□ (Optional)			□ (Optional)			□ (Optional)		□ (Optional)		□ (Optional)		□ (Optional)		
Alarm contact	□ (Optional)		□ (Optional)			□ (Optional)			□ (Optional)		□ (Optional)		□ (Optional)		□ (Optional)		
Fixed, front panel connection	■ (Standard)		■ (Standard)			■ (Standard)			■ (Standard)		■ (Standard)		■ (Standard)		■ (Standard)		
Plug-in front panel connection (not optional to 4P product)	□ (Optional)		□ (Optional)			□ (Optional)			□ (Optional)		□ (Optional)		□ (Optional)		□ (Optional)		
Plug-in rear panel connection	□ (Optional)		□ (Optional)			□ (Optional)			□ (Optional)		□ (Optional)		□ (Optional)		□ (Optional)		
Front panel connection transition plate	□ (Optional)		□ (Optional)			□ (Optional)			□ (Optional)		□ (Optional)		□ (Optional)		□ (Optional)		
Flash barrier	■ (Standard)		■ (Standard)			■ (Standard)			■ (Standard)		■ (Standard)		■ (Standard)		■ (Standard)		
Converter	□ (Optional)		□ (Optional)			□ (Optional)			□ (Optional)		□ (Optional)		□ (Optional)		□ (Optional)		

Note: L type of 100/125/160 is only available for 3P.

TGM1NE Series Moulded Case Circuit Breaker

Table 3, continued

Basic parameters											
Frame current I _{nm} (A)	630		630 ^s		800		1250		1600		
Number of poles	3P, 3P+N, 4P										
Frequency (Hz)	50/60										
Rated working voltage U _e (V)	380/400/415 500/550 660/690										
Rated insulation voltage U _i (V)	1000										
Rated impulse withstand voltage U _{imp} (kV)	12										
Rated current range I _n (A)	400AF:160-400 500AF:200-500 630AF:250-630		400AF:160-400 500AF:200-500 630AF:250-630		630AF:250-630 800AF:315-800		800AF:315-800 1000AF:400-1000 1250AF:500-1250		1250AF:500-1250 1600AF:630-1600		
Breaking capacity grade	M	H	M	H	M	H	M	H	M	H	
Rated limit short-circuit breaking capacity I _{cu} (kA)	AC415V	70	100	70	100	70	100	70	100	70	100
	AC550V	40	50	40	50	40	50	40	50	40	50
	AC690V	20	30	20	30	20	30	20	30	20	30
Rated operating short-circuit breaking capacity I _{cs} (kA)	AC415V	70	70	70	70	70	70	70	70	70	70
	AC550V	30	40	30	40	30	40	30	40	30	40
	AC690V	20	20	20	20	20	20	20	20	20	20
I _{ew} (kA/1s)	AC415V	8		8		10		20		20	
Isolation function	Yes (for 3P and 4P); No (for 3P+N)										
Flashover distance (mm)	≤100										
Mechanical life(times)	Without maintenance	10,000		10,000		10,000		5,000		5,000	
	With maintenance	20,000		20,000		20,000		10,000		10,000	
Electrical life(times)	8,000		8,000		8,000		2,500		2,500		
Protection function information											
Overload long-time delay protection	■ (Standard)		■ (Standard)		■ (Standard)		■ (Standard)		■ (Standard)		
Short-circuit short-time delay protection	■ (Standard)		■ (Standard)		■ (Standard)		■ (Standard)		■ (Standard)		
Short-circuit instantaneous protection	■ (Standard)		■ (Standard)		■ (Standard)		■ (Standard)		■ (Standard)		
Grounding protection	□ (Optional)		□ (Optional)		□ (Optional)		□ (Optional)		□ (Optional)		
Neutral pole protection	□ (Optional)		□ (Optional)		□ (Optional)		□ (Optional)		□ (Optional)		
Other function information											
Communication module (electronic shunt alarm accessory)	□ (Optional)		□ (Optional)		□ (Optional)		□ (Optional)		□ (Optional)		
Overload alarm non-trip	□ (Optional)		□ (Optional)		□ (Optional)		□ (Optional)		□ (Optional)		
Operation LED indicator	■ (Standard)		■ (Standard)		■ (Standard)		■ (Standard)		■ (Standard)		
Pre-alarm LED indicator	■ (Standard)		■ (Standard)		■ (Standard)		■ (Standard)		■ (Standard)		
Alarm LED indicator	■ (Standard)		■ (Standard)		■ (Standard)		■ (Standard)		■ (Standard)		
Accessory information											
Direct operation by handle	■ (Standard)		■ (Standard)		■ (Standard)		■ (Standard)		■ (Standard)		
USB data cable	□ (Optional)		□ (Optional)		□ (Optional)		□ (Optional)		□ (Optional)		
Extended rotating handle	□ (Optional)		□ (Optional)		□ (Optional)		□ (Optional)		□ (Optional)		
Electric motor operating mechanism	□ (Optional)		□ (Optional)		□ (Optional)		□ (Optional)		□ (Optional)		
Shunt release	□ (Optional)		□ (Optional)		□ (Optional)		□ (Optional)		□ (Optional)		
Undervoltage release	□ (Optional)		□ (Optional)		□ (Optional)		□ (Optional)		□ (Optional)		
Aux. contact	□ (Optional)		□ (Optional)		□ (Optional)		□ (Optional)		□ (Optional)		
Alarm contact	□ (Optional)		□ (Optional)		□ (Optional)		□ (Optional)		□ (Optional)		
Fixed, front panel connection	■ (Standard)		■ (Standard)		■ (Standard)		■ (Standard)		■ (Standard)		
Plug-in front panel connection (not optional to 4P product)	□ (Optional)		□ (Optional)		□ (Optional)		/		/		
Plug-in rear panel connection	□ (Optional)		□ (Optional)		□ (Optional)		/		/		
Front panel connection transition plate	□ (Optional)		□ (Optional)		□ (Optional)		/		/		
Flash barrier	■ (Standard)		■ (Standard)		■ (Standard)		■ (Standard)		■ (Standard)		
Converter	□ (Optional)		□ (Optional)		/		/		/		

Note: s is the code of standard volume, with the same below.

TGM1NE Series Moulded Case Circuit Breaker

3.2 Action characteristics

3.2.1 Overload long-time delay protection features

Table 4

Usage and current		Tripping time(t_r)								
For power distribution	1.05I _r	No tripping ≤2h / when I _r ≤ 63A, No tripping ≤ 1h								
	1.3I _r	Action ≤ 1h								
	2I _r	Current section (A)	100/125/160/250/320				400/630/630 ⁰ /800/1250/1600			
Setting time I _r (s)		12	60	80	100	12	60	100	150	
For motor protection	1.0I _r	No tripping ≤2h / when I _r ≤ 63A, No tripping ≤ 1h								
	1.2I _r	Tripping ≤ 1h								
	1.5I _r	Current section (A)	100/125/160/250/320				400/630/630 ⁰ /800/1250/1600			
		Action time (s)	21.3	107	142	178	21.3	107	178	267
	2I _r	Setting time I _r (s)	12	60	80	100	12	60	100	150
	7.2I _r	Action time (s)	0.93	4.63	6.17	7.72	0.93	4.63	7.72	11.6
	Trip level		/	10A	10	20	/	10	20	30
Notes: 1. Action time complies with $T1=(2I_r/I)^2t_r$; 2. Action time tolerance is ±20%.										

3.2.2 Short-circuit short-time delay protection features

Table 5

Current set value	Action characteristics	Trip duration(t_{sd})					
I _{sd} : 2~12I _r Adjustable (closed)	I _{sd} ≤ I < I _i	Definite time	Time	0.06	0.1	0.2	0.3 (Default)
			Tolerance	±0.02	±0.03	±0.04	±0.06
			Return time	/	/	0.14	0.21
Note: The action current tolerance is ±15%.							

3.2.3 Short-circuit instantaneous protection features

Table 6

Current set value	Action characteristics	Trip duration (t_{sd})
I _i : 4~14I _r Adjustable (closed)	≤0.85I _i	No action
	≥1.15I _i	<0.2s

TGM1NE Series Moulded Case Circuit Breaker

3.2.4 Grounding protection features

Table 7

Current set value	Action characteristics	Trip duration (t_{sd})
I_g : 0.7~1In Adjustable (closed)	$I < 0.9I_g$	No action
	$I \geq 1.1I_g$	0.1s, 0.2s, 0.3s, 0.4s (Default)
Note: I_g setting range is 0.4 ~ 1In that is adjustable (closed) for frame current 1250A and 1600A		

3.2.5 Alarm functions

Table 8

Current set value	Action characteristics	Description
I_p : 0.7~1I _r adjustable (closed)	Overload alarm non-trip	Only communication adjustment supported

3.2.6 Neutral pole protection features

Table 9

Current set value	Gear setting	Description
I_m : 0.5~1I _r adjustable (closed)	0.5I _r	Long-time delay, short-time delay, and instantaneous current set value of the neutral line equal to 1/2 of protection set value of the phase line, and the time equals to that of the phase line protection.
	1I _r	Long-time delay, short-time delay, and instantaneous current set value of the neutral line equal to the protection set value of the phase line, and the time equals to that of the phase line protection.

4 Operating Conditions

- 4.1 Ambient air temperature: -5°C ~ +40°C; the mean temperature within 24h does not exceed +35°C; please contact the manufacturer when the ambient air temperature exceeds +40°C or below -5°C;
- 4.2 Installation altitude: ≤2,000 meters;
- 4.3 The relative air humidity does not exceed 50% at the maximum temperature +40°C, and a higher relative humidity is allowed at a low temperature; the mean temperature does not exceed +25°C in the wettest month, and the maximum mean relative humidity of that month does not exceed 90%. Necessary measures are taken for condensation occurred occasionally due to temperature changes;
- 4.4 Installed in places whether there is no impact vibration or rain and snow invasion;
- 4.5 Installed in places whether there is no explosive or hazardous medium, and there is no enough gas or conductive dust to cause corrosion to the metal or damage to the insulation;
- 4.6 1, 3, 5, and LINE are connected to the power side; 2, 4, 6, LOAD are connected to the load side; the circuit breaker can be installed vertically (vertical installation), and can be installed horizontally (lateral installation); reverse connection is prohibited;
- 4.7 Pollution degree: 3;
- 4.8 The installation category of main circuit is III, and of the auxiliary circuit and control circuit not connected to main circuit is II;
- 4.9 The external magnetic field near the circuit breaker installation site shall not exceed 5 times earth's magnetic field in any direction;
- 4.10 Please handle the product with care, do not put it upside down and avoid severe collision during transport.

TGM1NE Series Moulded Case Circuit Breaker

5 Tripper Mode and Accessory Code

5.1 Internal accessory code table

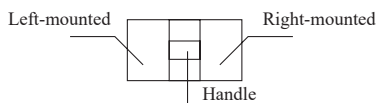

Alarm contact ● Aux. contact ○ Shunt release ■
Undervoltage release ▲ Shunt release of prepaid meter ★
Communication module (electronic shunt alarm accessory) ◇
Overload alarm non-trip ◆

Table 10

Accessory name	Accessory code	TGM1NE-100	TGM1NE-250	TGM1NE-400	TGM1NE-630 ^S	TGM1NE-800	TGM1NE-1250	TGM1NE-1600
		TGM1NE-125	TGM1NE-320	TGM1NE-630				
		Default configuraion	Default configuraion	Default configuraion	Default configuraion	Default configuraion	Default configuraion	Default configuraion
No accessory	00							
Alarm contact	08							
Shunt release	10							
Aux. contact	20							
Undervoltage release	30							
Shunt release Aux. contact	40							
Shunt release Undervoltage release	50							
Two sets of aux. contacts	60							
Aux. contact Undervoltage release	70							
Shunt release Alarm contact	18							
Aux. contact Alarm contact	28							
Undervoltage release Alarm contact	38							
Shunt release Aux. contact Alarm contact	48							
Two sets of aux. contacts Alarm contact	68							
Undervoltage release Aux. contact Alarm contact	78							
Prepaid meter Shunt release								
Communication module (electronic shunt alarm accessory)								
Overload alarm non-trip backpack								

- Note: 1. Left-mounted and right-mounted modes are available for internal accessories. Please specify the accessory installation direction when ordering (such as right shunt); the default setting is available unless otherwise specified.
2. Prepayment shunt release is suitable for 160-800 frame current.
3. One set of aux. contacts for 400 type and below and for 1250 type and above contains one normally open contact and one normally closed contact, and for 400-800 type contains two normally open contacts and two normally closed contacts (except for aux. alarm contacts 28/48/68/78).

TGM1NE Series Moulded Case Circuit Breaker

6 Electronic Release

6.1 Indicator state

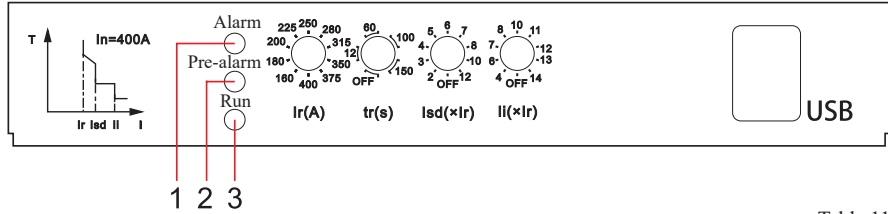

Table 11

	Indicator description	Indicator run state description
1	Alarm LED indicator (red)	When $I > 1.05I_r$, the overload alarm indicator is on; when $I \leq 1.0I_r$, the overload alarm indicator is off;
2	Prealarm LED indicator (yellow)	When $I > 1.1I_p$, the prealarm alarm indicator is on; when $I \leq 0.9I_p$, the prealarm alarm indicator is off (the prealarm set value is $0.9 I_r$ by default)
3	Operation LED indicator (green)	When $I > 0.4I_n$, the run indicator flashes (lit once per second); when $I \leq 0.35I_n$, the run indicator flashes slowly (lit once per 2 seconds)

6.2 Four-button type controller (common type)

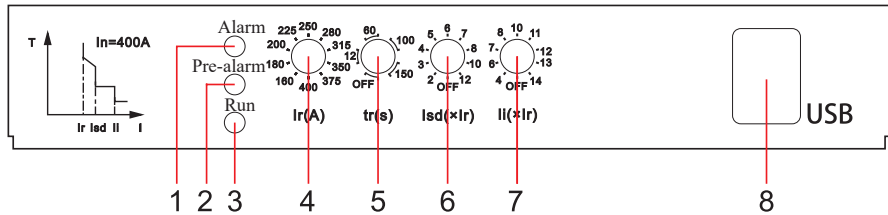

Table 12

Four-button intelligent controller information		
1	Alarm LED indicator (red)	Default parameters 1 The default setting value of short-circuit short-time delay time is $t_{sd} = 0.3s$ 2 The default setting value of overload prealarm current is $I_p = 0.9 \times I_r$
2	Prealarm LED indicator (yellow)	
3	Operation LED indicator (green)	
4	Overload long-time delay current setting value $I_r(A)$	
5	Overload long-time delay time setting value $I_r(s)$	
6	Short-circuit short-time delay current setting value $I_{sd}(A)$	
7	Short-circuit instantaneous current setting value	
8	USB interface	

TGM1NE Series Moulded Case Circuit Breaker

6.3 Neutral pole protection controller (E1 type)

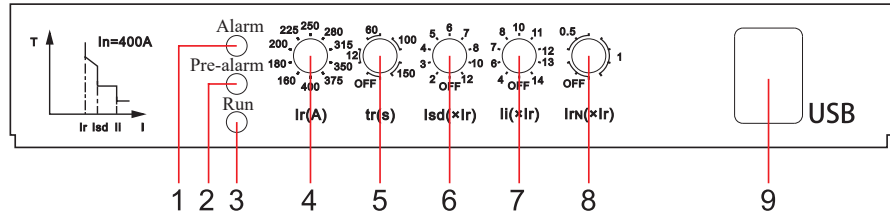

Table 13

Five-button intelligent controller information	
1	Alarm LED indicator (red)
2	Prealarm LED indicator (yellow)
3	Operation LED indicator (green)
4	Overload long-time delay current setting value $I_r(A)$
5	Overload long-time delay time setting value $I_r(S)$
6	Short-circuit short-time delay current setting value $I_{sd}(A)$
7	Short-circuit instantaneous current setting value $I_i(A)$
8	Neutral pole protection current setting value $I_m(A)$
9	USB interface

Default parameters
 1 The default setting value of short-circuit short-time delay time is $t_{sd} = 0.3s$
 2 The default setting value of overload prealarm current is $I_p = 0.9 \times I_r$

6.4 Grounding type protection controller (E3 type)

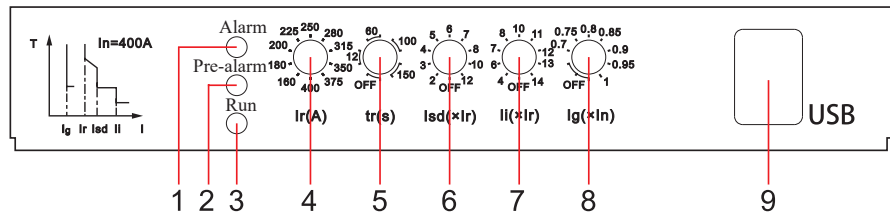

Table 14

Five-button intelligent controller information	
1	Alarm LED indicator (red)
2	Prealarm LED indicator (yellow)
3	Operation LED indicator (green)
4	Overload long-time delay current setting value $I_r(A)$
5	Overload long-time delay time setting value $I_r(S)$
6	Short-circuit short-time delay current setting value $I_{sd}(A)$
7	Short-circuit instantaneous current setting value $I_i(A)$
8	Grounding protection current setting value $I_g(A)$
9	USB interface

Default parameters
 1 The default setting value of short-circuit short-time delay time is $t_{sd} = 0.3s$
 2 The default setting value of overload prealarm current is $I_p = 0.9 \times I_r$
 3 The setting value of grounding protection time is $t_g = 0.4s$
 4 The setting range for 1250 shell frame and 1600 frame current is $0.4 \sim 1I_n$ (it can be closed).

TGM1NE Series Moulded Case Circuit Breaker

6.5 Communication type controller (E2 type)



Table 15

Communication type controller information		
1	Alarm LED indicator (red)	Default parameters 1 The default setting value of short-circuit short-time delay time is $t_{sd} = 0.3s$ 2 The default setting value of overload prealarm current is $I_p = 0.9 \times I_r$
2	Prealarm LED indicator (yellow)	
3	Operation LED indicator (green)	

6.6 Usage of USB data interface

It is interconnected through USB data interface, dedicated cable and Android phone that supports OTG function.

1. Prerequisites for interconnection:

Mobile phone: Turn on the OTG function of Android mobile phone that supports OTG function, and download the "TENGEN Xiangyun Zhilian" mobile phone App before use; for phone download connection, visit "TENGEN official website - download center - TENGEN Xiangyun Zhilian";

Special cable: Optional accessories;

The USB data interface of the product - the special connection cable – start the APP after the normal connection of the mobile phones of three parties for use; the initial login password of the App is "0000".

2. TENGEN Xiangyun Zhilian App currently supports TGM1NE Xiangyun electronic moulded case series products;

3. TENZHENG Xiangyun Zhilian App realizes partial remote regulating and telemetry functions of mobile phones and circuit breakers.

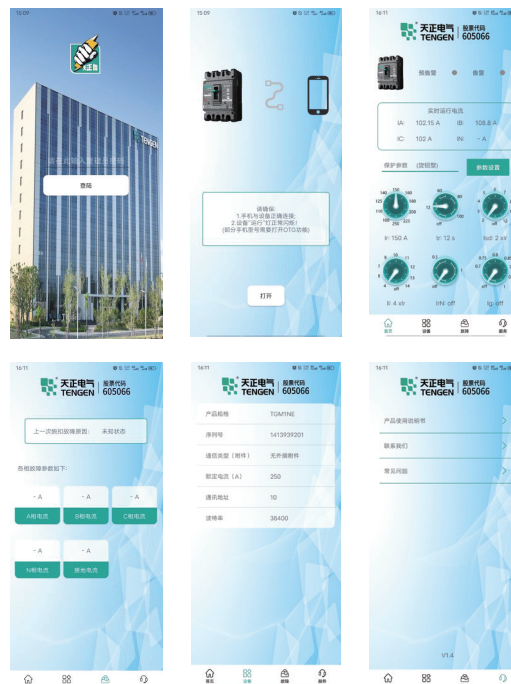

TGM1NE Series Moulded Case Circuit Breaker

7 Technical Data

7.1 Before installing circuit breaker:

- a) Check whether technical parameters on the nameplate meet the requirements;
- b) Please open and close the circuit breaker several times and check the circuit breaker operating mechanism for blockage and the mechanism for reliable action.

7.2 When installing circuit breaker:

- a) “1”, “3”, “5”, and “LINE(N)” of circuit breaker are incoming terminals, and “2”, “4”, “6”, and “LOAD(N)” are outgoing terminals;
- b) The recommended sectional areas of the connecting wire corresponding to the rated current of release are shown in Table 16; the screw tightening torques are listed in Table 17 to ensure normal operation of circuit breaker.

7.2.1 Reference sectional areas of connecting wire under different rated current

Table 16

Rated current I_n (A)	32	63	100	125	160	250	320	400
Sectional area of wire (mm ²)	6	16	35	50	70	120	185	240

Rated current I_n (A)	Cable		Copper bar	
	Sectional area (mm ²)	Qty.	Size (mm x mm)	Qty.
630	185	2	40 x 5	2
800	240	2	50 x 5	2
1250	/	/	80 x 5	2
1600	/	/	100 x 5	2

Note: Wiring board with the thickness 10mm is recommended for TGM1NE-1250/1600; if there is a wiring board with other thickness, please contact the manufacturer to customize the wiring screws of the corresponding length to prevent that wiring screws are tightened not firmly or damaged resulting in short circuit between the phases.

7.2.2 Screw tightening torques

Table 17

Product model	TGM1NE-100/125/160	TGM1NE-250/320	TGM1NE-400/630
Nominal diameter of thread (mm)	M8	M8	M10
Tightening torque (N.m)	10	12	22
Failure moment (N.m)	15	18	26

Product model	TGM1NE-630*	TGM1NE-800	TGM1NE-1250	TGM1NE-1600
Nominal diameter of thread (mm)	M12	M12	M10	M10
Tightening torque (N.m)	28	28	18	18
Failure moment (N.m)	33	33	22	22

7.3 Select the circuit breaker with different rated current according to the requirements of protective objects, otherwise the correct protection cannot be realized.

TGM1NE Series Moulded Case Circuit Breaker

7.4 Power loss

Table 18

Product model	Power current (A)	Total power loss of 3P/4P(W)		
		Front panel/ Rear panel connection	Plug-in front panel connection	Plug-in rear panel connection
TGM1NE-100	100	10	10	11
TGM1NE-125	125	12	12	12.2
TGM1NE-160	160	40	50	62
TGM1NE-250	250	50	75	86
TGM1NE-320	320	55	80	89
TGM1NE-400	400	58	87	90
TGM1NE-630/630 ^s	630	110	120	130
TGM1NE-800	800	115.2	125	140

7.5 Derating coefficient under different temperature

Table 19

Product model	Power current (A)	Ambient temperature						
		-35°C	-30°C	-25°C	-20°C	-15°C	-10°C	-5°C
TGM1NE-100	100	1In	0.95In	0.94In	0.93In	0.92In	0.91In	0.89In
TGM1NE-125	125	1In	0.95In	0.94In	0.93In	0.92In	0.91In	0.89In
TGM1NE-160	160	1In	0.95In	0.94In	0.93In	0.92In	0.91In	0.89In
TGM1NE-250	250	1In	0.95In	0.9In	0.89In	0.85In	0.81In	0.78In
TGM1NE-320	320	1In	0.95In	0.9In	0.89In	0.85In	0.81In	0.78In
TGM1NE-400	400	1In	0.95In	0.9In	0.89In	0.85In	0.81In	0.78In
TGM1NE-630/630 ^s	630	1In	0.95In	0.94In	0.92In	0.9In	0.87In	0.86In
TGM1NE-800	800	1In	0.95In	0.93In	0.85In	0.82In	0.8In	0.78In
TGM1NE-1250	1250	1In	0.95In	0.93In	0.85In	0.82In	0.8In	0.78In
TGM1NE-1600	1600	1In	0.95In	0.93In	0.85In	0.82In	0.8In	0.78In

- (1) Derating coefficient is measured at the maximum rated current of each frame for TGM1NE circuit breaker.
- (2) When the ambient temperature is lower than 40°C, the product can work normally and the derating not required.

TGM1NE Series Moulded Case Circuit Breaker

8 Introduction to Product Accessory

Complete internal accessories and external accessories are provided for moulded case circuit breaker to satisfy the needs of different client.

8.1 Internal accessory code

Table 20

OF	1N	-	125	L	D	A2
Accessory code	Adaptive circuit breaker code		Frame current code	Installation position	Wire leading-out mode	Voltage grade
OF: Aux. contact	1N:TGM1NE		100, 125, 160, 250, 320, 400, 630, 630 ^s , 800, 1250	L: Left R: Right	Default: Direct wire leading out D: Wiring terminal box	Default: No A1: AC220 / 230 / 240V A2: AC380 / 400 / 415V D1: DC24V D2: DC110V D3: DC220V
SD: Alarm contact						
MN: Undervoltage release						
MX: Shunt release						

8.1.1 Aux. contact OF



- It is an accessory that is connected to the auxiliary circuit of circuit breaker to indicate the ON or OFF/Free trip state of circuit breaker remotely.

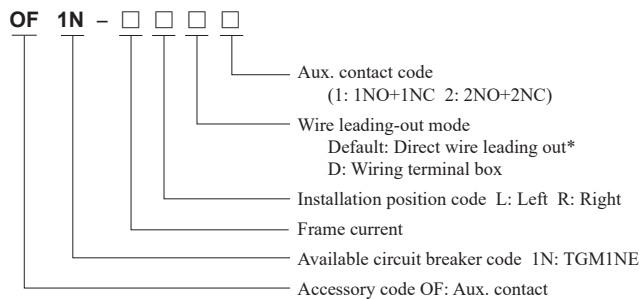

*Note: The direct leading out length of wire is 50cm by default; please specify other length if required when ordering.

For example: The code of right auxiliary contact with a terminal box for TGM1NE series 250 shell frame is OF1N-250RD2.

- Wiring diagram

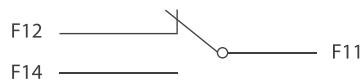

Status of the circuit breaker at "free tripping" and "OFF" positions

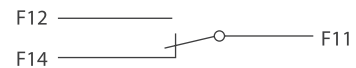

Status of the circuit breaker at "ON" positions

- Main parameters

Table 21

Resistive current Ith (A)	Rated insulation voltage Ui (V)	Rated working current Ie (A)		Range
		AC-15(380-400-415V)	DC-13(110-220-250V)	
3	690	0.3	0.15	Inm≤320A
6	690	1	0.15	Inm≥400A

TGM1NE Series Moulded Case Circuit Breaker

8.1.2 Undervoltage release MN

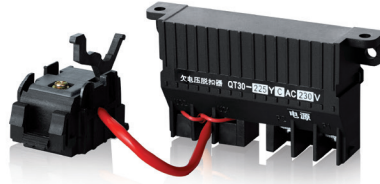

- To realize the undervoltage protection of circuit breaker; disconnect the circuit breaker when the power voltage is too low for protection of electrical equipment
 - a When the voltage is 35%-70% of rated working voltage, the undervoltage release shall work reliably to trip circuit breaker;
 - b When the voltage is 85%-110% of rated working voltage, the undervoltage release shall work to close circuit breaker;
 - c When the voltage is below 35% rated working voltage, the undervoltage release shall work reliably to prevent the circuit breaker being closed;

*Note: The undervoltage release must be powered on, and then the circuit breaker is connected and closed, otherwise this may cause damage to the circuit breaker.

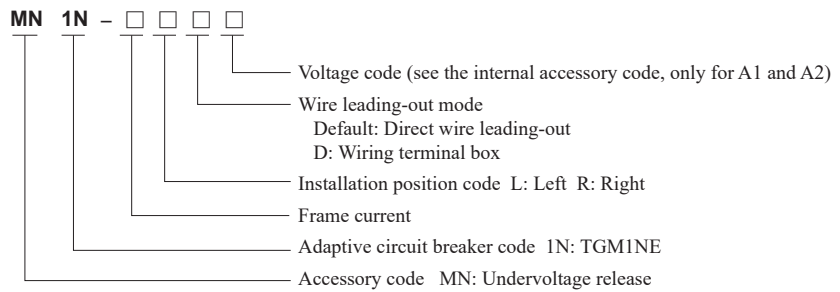

Note: the lead-out length of the direct wire is 50cm by default. Please specify other lengths when ordering.

Example: TGM1NE series frame current 250A with undervoltage AC220 (direct lead out) model code: MN1N-250LA1

- Wiring diagram

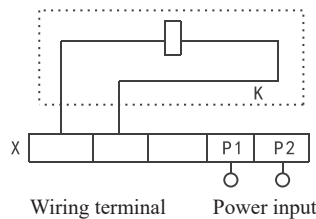

*Note: The internal wiring diagram of circuit breaker is shown in dashed box

- Electrical specifications

Table 22

Product model	Starting current (mA)		Power (W)	
	AC400V	AC230V	AC400V	AC230V
TGM1NE-100/125/160	9.95	15.55	4.55	3.82
TGM1NE-250/320	10.88	15.83	4.85	3.92
TGM1NE-400/630/630 [*]	9.5	11.2	3.8	2.83
TGM1NE-800	5.4	7.75	2.7	1.85
TGM1NE-1250	5.4	7.75	2.7	1.85
TGM1NE-1600	5.4	7.75	2.7	1.85

TGM1NE Series Moulded Case Circuit Breaker

8.1.3 Alarm contact SD



- It is an accessory that is connected to the auxiliary circuit of circuit breaker to indicate the state of circuit breaker at the non-trip (ON or OFF) or trip (Trip) position

There may be four trip indications issued by an alarm contact:

- Overload or short-circuit fault
- Residual current fault
- Test button trip
- Shunt/Undervoltage release

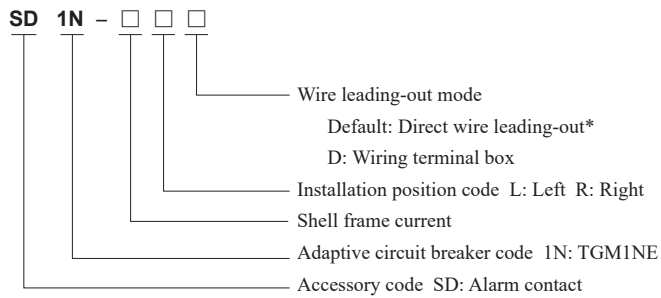

*Note: The direct leading-out length of wire is 50cm by default; please specify other length if required when ordering.

For example: The code of left alarm (direct wire leading-out) for TGM1NE series 250 shell frame is SD1N-250L.

- Wiring diagram

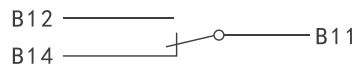

Circuit breaker at the free trip (alarm) state

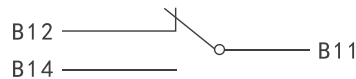

Circuit breaker at the "OFF" or "ON" state

- Main Parameters

Table 23

Resistive current I _{th} (A)	Rated insulation voltage U _i (V)	Rated working current I _e (A)		Range
		AC-15(380-400-415V)	DC-13(110-220-250V)	
3	690	0.3	0.15	I _{nm} ≤ 320A
6	690	1	0.15	I _{nm} ≥ 400A

TGM1NE Series Moulded Case Circuit Breaker

8.1.4 Shunt release MX

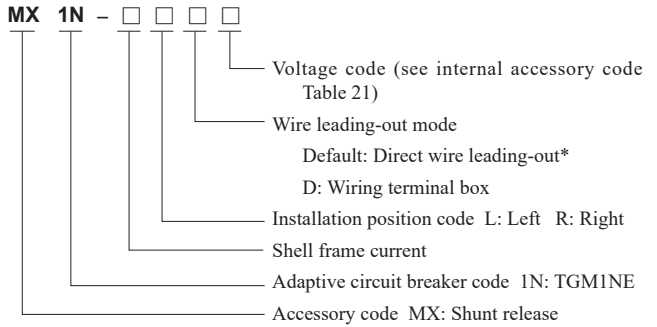

- To disconnect the circuit breaker remotely When the rated control power voltage U_s is ranged 70% to 110%, the shunt release can work reliably to make circuit breaker trip

*Note: The direct leading out length of wire is 50cm by default; please specify other length if required when ordering (the maximum length of lead wire is 100mm).

For example: The code of left shunt DC220 (direct wire leading-out) for TGM1NE series 250 shell frame is MX1N-250LD3.

- Wiring diagram

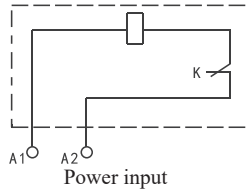

*Note:

K – The microswitch that the shunt release is connected to the coil internally in series is a normally-closed contact; when the circuit breaker is off, this contact will open automatically, and is closed if on.

When the control voltage is DC24V, the maximum length of copper wire meets the following requirements and the rated current at the release wiring terminal shall reach $5A \pm 0.5A$:

Table 24

Rated control power voltage U_e (DC24V)	Sectional area of wire	
	1.5mm ²	2.5mm ²
100% power voltage	150m	250m
85% power voltage	100m	160m

The below figure is recommended in the circuit design of shunt controller, If control voltage doesn't meet criteria of the above table:

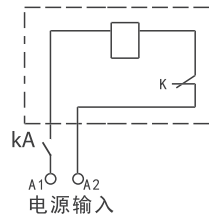
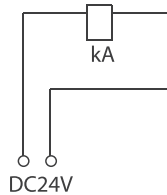

*Note:

KA is DC24V intermediate relay, and the current capacity of contact is 1A.

- Electrical specification

Table 25

Product model	Starting current (mA)				Power (W)			
	AC400V	AC230V	DC220V	DC24V	AC400V	AC230V	DC220V	DC24V
TGM1NE-100/125/160	0.35	0.45	0.37	4.52	95.8	73	90.7	91.2
TGM1NE-250/320	0.42	0.48	0.39	4.51	112	68.8	90.7	85.3
TGM1NE-400/630/630*	0.48	0.51	0.41	4.51	132	78.3	94.4	110
TGM1NE-800	0.54	0.85	1.21	5.51	163	153	158	120
TGM1NE-1250	0.85	1.31	1.72	5.82	185	173	166	130
TGM1NE-1600	0.85	1.31	1.72	5.82	185	173	166	130

TGM1NE Series Moulded Case Circuit Breaker

8.2 External accessories and code

Table 26

LCD2	1N	-	125	A2	
Accessory code	Adaptive circuit breaker code		Frame current code	Voltage grade	Number of poles
AH: Round manual operated handle	1N:TGM1NE		100, 125, 160, 250, 320, 400, 630, 630 ^o , 800, 1250, 1600	A1: AC220 / 230 / 240V A2: AC380 / 400 / 415V D1: DC24V D2: DC110V DC3: DC220V	Three-pole: 3P Four-pole: 4P
RH: Square manual operated handle					
LCD2: Common AC and DC motor mechanism					
GP: Front panel connection wiring transition plate					
GB: Phase partition					
BH: Rear panel connection					
LS: Mechanical interlock					

8.2.1 Manual operating mechanism RN/AH

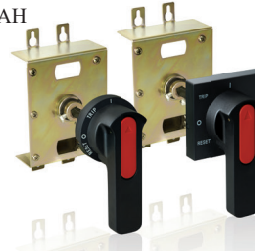

- Operate the circuit breaker through turning the handle; the rotary handle that meets the ergonomic design requirements is used for more flexible operation of circuit breaker

There are two forms of manual operated mechanism for TGM1NE series circuit breaker:

Extended rotary handle (round extended manual operating handle, square extended manual operating handle)

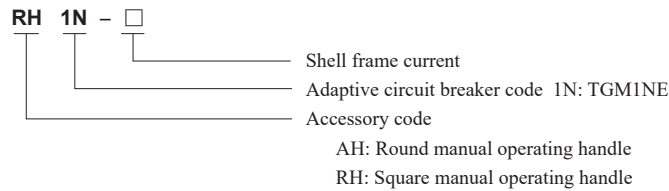

For example: The code of round manual operating handle for TGM1NE series 250 frame is AH1N-250.

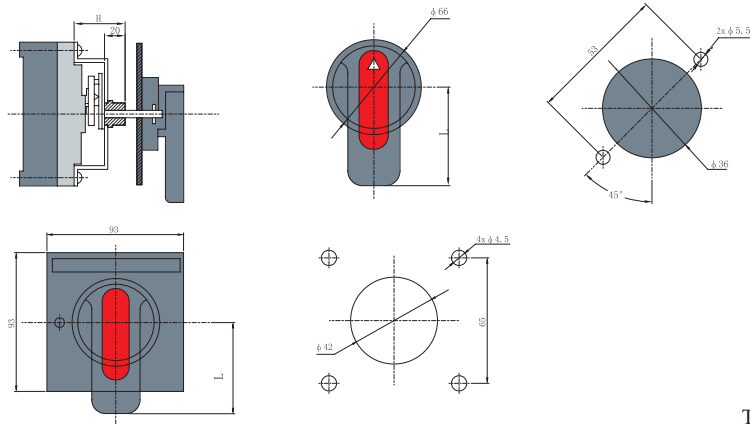

Table 27

Model & Spec.	TGM1NE-100/125/160	TGM1NE-250/320	TGM1NE-400/630	TGM1NE-630 ^o	TGM1NE-800	TGM1NE-1250
Installation dimension (H)	61	57	87	88	87	93
Handle length (L)	65	95	125	125	125	93

*Note: The default length of the extended rod of manual handle is 150mm, and the maximum length is 500mm (specification graded by 50mm increment).

TGM1NE Series Moulded Case Circuit Breaker

8.2.2 Electric motor operating mechanism LCD2



- It is used for remote and electric closing, opening and trip of circuit breaker and for automatic control application

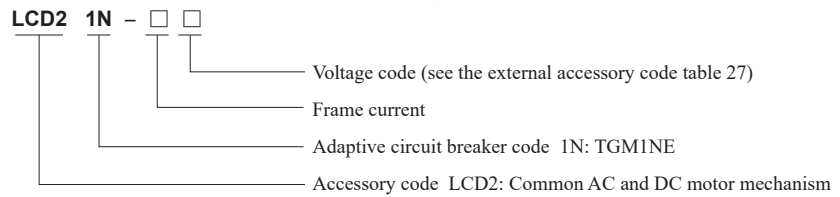

*Example: The code of motor mechanism AC380V for TGM1NE series 250 frame is LCD21N-250A2.

- Electrical specifications and wiring diagram

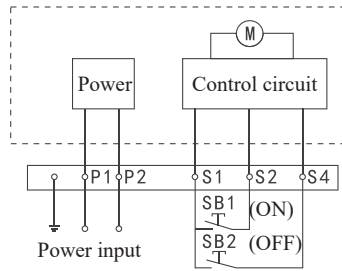

*Note:

K - Microswitch that the shunt release is connected to the coil internally in series is a NC contact. When the circuit breaker opens, this contact will open automatically, and is off when closed.

P1 and P2 are external connection and power input, respectively

SB1 and SB2 are operating buttons (provided by user)

- Outline and installation dimensions

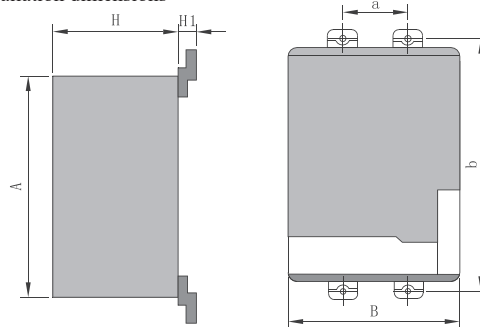
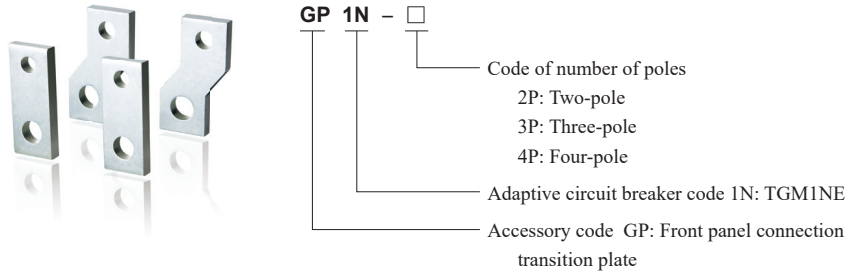

Table 28

Model	A	B	H	H1	a	b
TGM1NE-100/125/160	116	90	79	20.5	30	129
TGM1NE-250/320	116	90	79	16.5	35	126
TGM1NE-400/630	174	130	117	35.5	44	194
TGM1NE-630 ⁸	174	130	117	28.5	58	200
TGM1NE-800	174	130	117	33.5	70	243
TGM1NE-1250	174	130	117	35.5	70	300
TGM1NE-1600	174	210	75	/	70	303

TGM1NE Series Moulded Case Circuit Breaker

8.2.3 Front panel connecting transition plate GP



- It is used for more flexible wiring way of circuit breaker, and the phase distancing is increased by adding this part, improving the safety between the lines

Note: The expanded terminal code only contains transition bar of the incoming terminal or outgoing terminal (such as, only three wiring plates are provided for 3P); please order two sets if transition bars are required for both incoming and outgoing terminals.

Example: The code of 3P transition plate for TGM1NE series 250 frame is GP1N-2503P.

8.2.4 Phase partition GB

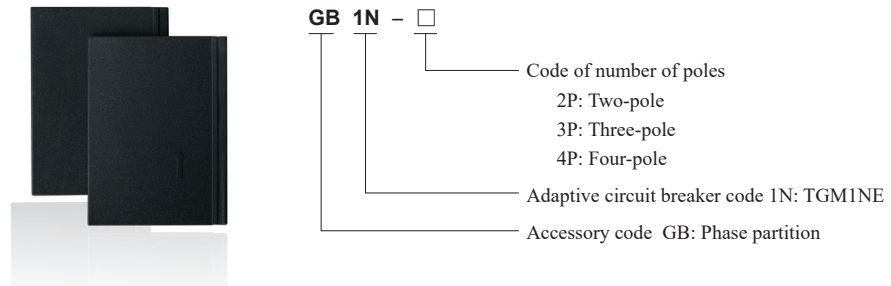

- It is used to improve the insulation performance of the conductor between the phases; it can be installed from the front slot even when the switch has been installed.

*Note: The phase partition is as standard part when shipment, one circuit breaker (two pieces for 2-pole, four pieces for 3-pole, six pieces for 4-pole)

Example: The code of 3P phase partition for TGM1N series 250 frame is GB1N-2503P.

8.2.5 Rear panel connection BH

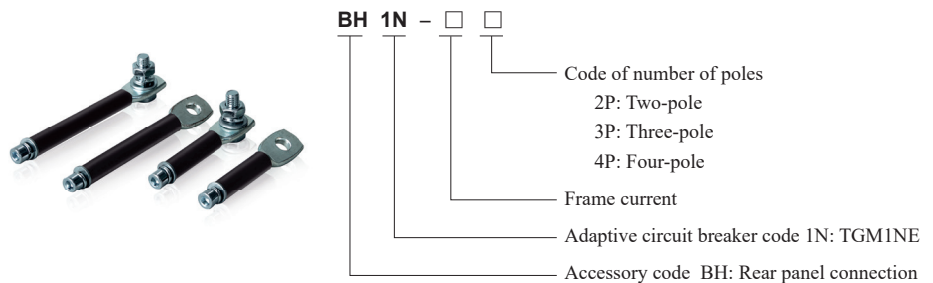

- It is used for more flexible wiring way of circuit breaker, and the back-plate wiring can be realized by adding this accessory

Example: The code of 3P rear panel for TGM1NE series 250 frame is BH1N-2502P.

TGM1NE Series Moulded Case Circuit Breaker

8.2.6 Mechanical interlock LS

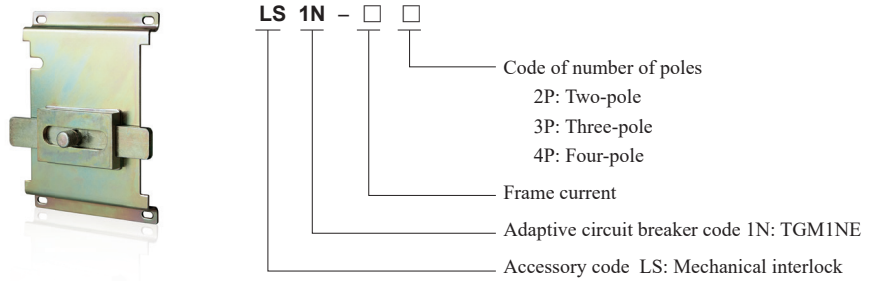

- It is used to realize that two circuit breakers are interlocked to prevent them from closing.
Example: The code of mechanical interlock for TGM1NE series 250 frame is LS1N-2503P

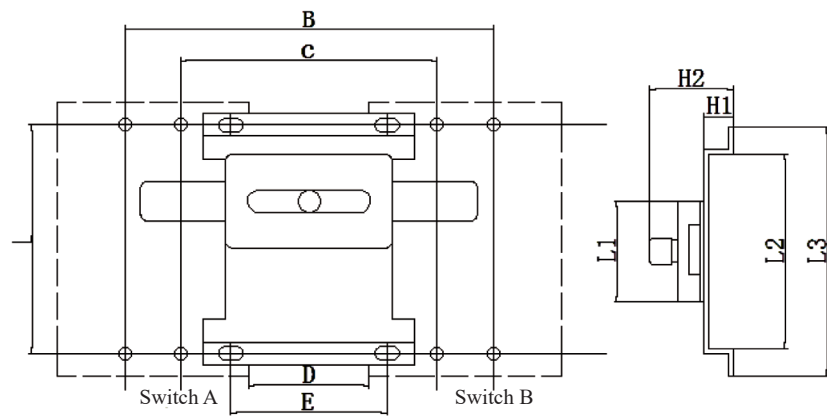

Outline and installation dimension diagram of TGM1NE series 3P mechanical interlock

Table 29

Model & Spec.	Outline and installation dimensions (mm)								
	B	C	D	E	L1	L2	L3	H1	H2
TGM1NE-100/125/160	151	91	28.5	36	40	101	122	25	48
TGM1NE-250/320	170	100	28	100	40	128	155	25	48
TGM1NE-400/630	221.5	133.5	27.5	41	60	179	207	30.5	55
TGM1NE-800	320	180	40	52	60	229	254	30.5	55

TGM1NE Series Moulded Case Circuit Breaker

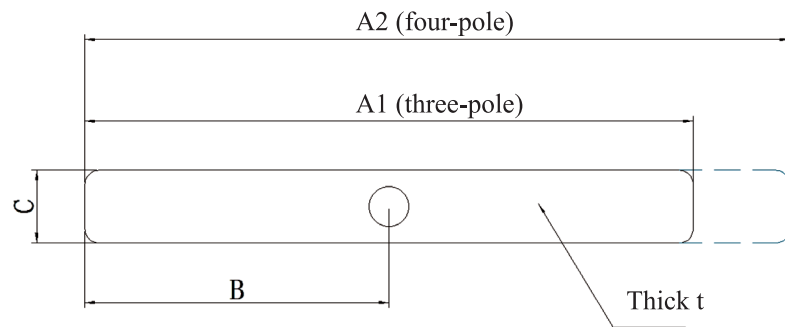

Table 30

Model & Spec.	Outline dimensions of slip strip (mm)				
	A1	A2	B	C	t
TGM1NE-100/125/160	120	152	60	22	5
TGM1NE-250/320	130	166	65	22	5
TGM1NE-400/630	190	235	96	28	6
TGM1NE-800	250	323	125	28	6

8.3 Prepaid meter shunt release

8.3.1 Difference between the prepaid meter shunt release and the common shunt release: The iron core will be pulled in to drive the product act after the common shunt release is powered on; there are two states for prepaid shunt:

- Iron core will be pulled after a delay 0.5-2s after P1 and P2 are powered on directly to drive the product act.
- P1 and P2 powered iron core will not be pulled in after UC1 and P1 are powered on, and the product will not work.

8.3.2 Prepaid svhunt release control power voltage: AC220V, 50Hz.

8.4 Backpack function

8.4.1 Communication backpack

- The backpack is used to realize “three-remote” or “four-remote” functions;
- The backpack is used to realize passive shunt function without additional shunt accessories required.

8.4.2 Overload alarm non-trip/overload alarm trip backpack

- The backpack is used to realize the overload alarm non-trip function;
- Overload alarm non-trip/trip can be switched via the button;
- The backpack is used to realize the alarm signal output without additional alarm contact accessory required.

8.4.3 Backpack power AC230/400V self-adaption or DC24V; backpack wiring diagram and its function refer to Article 8.6.

8.5 Five-button controller

Difference between five-button controller and four-button controller: The five-button controller is a circuit board with an adjustable five-position button; four-button controller is a circuit board with an adjustable four-position button.

TGM1NE Series Moulded Case Circuit Breaker

8.6 TGM1NE series communication module (electronic shunt alarm accessory)

8.6.1 Product functions

Communication module (electronic shunt alarm accessory) (hereinafter referred to as communication module) has seven function areas such as auxiliary output without power, alarm output without power, shunt output without power, auxiliary input without power, alarm input without power, RS485 communication, and motor operation based on Modbus protocol. The communication module can be connected to TGM1NE circuit breaker through accessories such as motor mechanism and auxiliary alarm to realize telecontrol, tele-regulation, telemetering, and telesignalling functions of product.

The overload alarm non-trip module has alarm output without power function; that is, when the actual current of circuit breaker is greater than the overload trip current, the alarm output without power is switched and the backpack's alarm indicator is on when the circuit breaker reaches the trip duration, but the circuit breaker does not trip.

8.6.2 Technical parameters

Table 31

No.	Name	Rated voltage
1	Communication module (electro shunt alarm accessory)	AC230V/AC400V, DC24V
2	Overload alarm non-trip module	AC230V/AC400V, DC24V

8.6.3 Communication module function debugging

8.6.3.1 Introduction to communication module

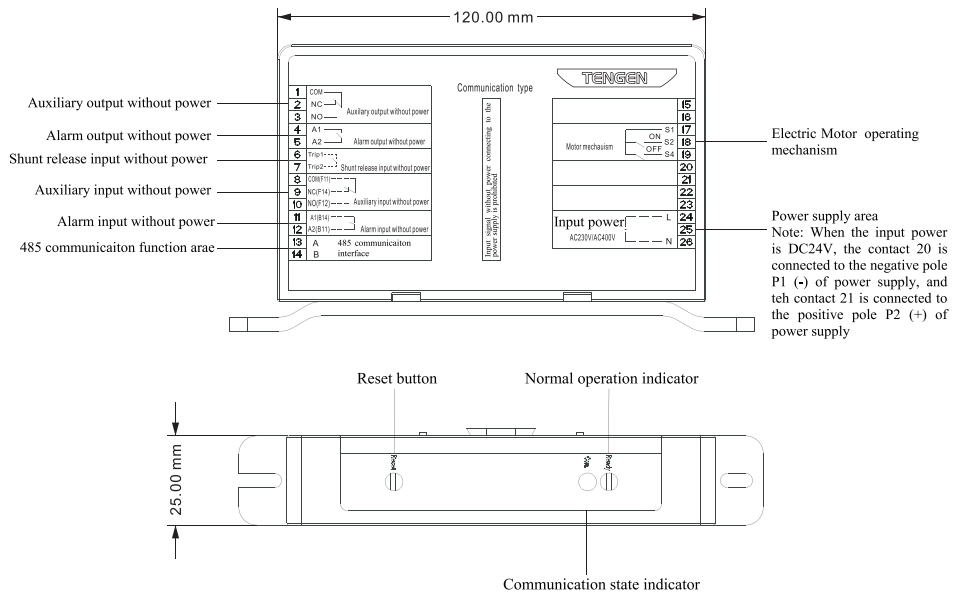

Fig. 1 Introduction to communication module

Contacts 17 (S1), 18 (S2) and 19 (S4) are connecting contacts in the motor mechanism control area to connect each interface in the communication module motor mechanism control function area to the corresponding interface of motor mechanism to realize the remote control of product opening and closing operation via communication module. The communication module and motor mechanism assembly effect are shown in Fig. 2.

TGM1NE Series Moulded Case Circuit Breaker

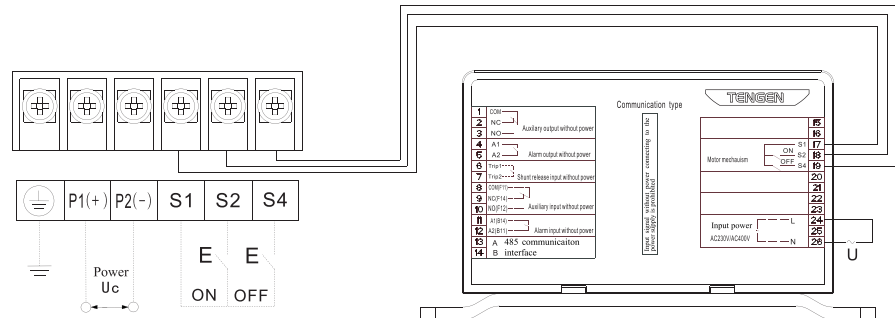

Fig. 2 Communication module and Electric motor operating mechanism assembly drawing

8.6.3.2 Function area of auxiliary input without power

The function area of auxiliary input without power receives the signal from the auxiliary accessory; contact 9 (F12) is a normally-open contact, contact 10 (F14) is a NC contact, and contact 8 (F11) is a common contact to connect contacts 8, 9, and 10 of communication module to the contacts F11, F12, and F14 of auxiliary, respectively, realizing the telesignaling function of product, and realizing the telecontrol and telesignaling functions by combining with motor mechanism. In addition, with this function, the auxiliary signal can be transferred to the function area of auxiliary output without power. The wiring method is shown in Fig. 3.

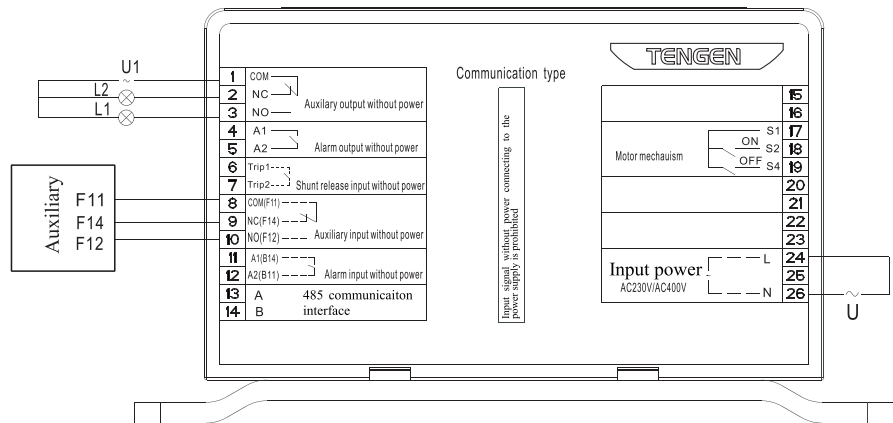

Fig. 3 Auxiliary and communication module wiring diagram

TGM1NE Series Moulded Case Circuit Breaker

8.6.3.3 Function area of alarm input without power

The function area of alarm input without power receives the signal from the alarm accessory. Contacts 11 (B14) and 12 (B11) are connected to the NO contact B14 of alarm and the common contact B11, respectively. This function can transfer the alarm signal to the function area of alarm output without power. The wiring method is shown in Fig. 4.

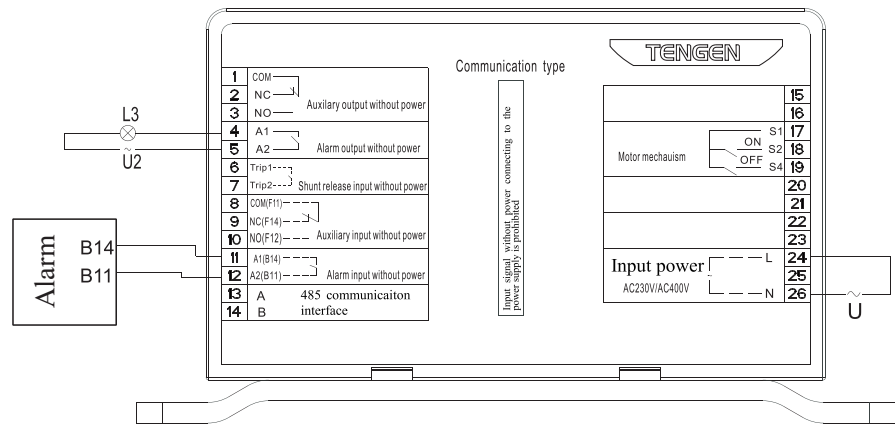

Fig. 4 Alarm and communication module wiring diagram

8.6.3.4 Function area of shunt input without power

The function area of shunt input without power can control the tripping action of circuit breaker. Contacts are 6 (Trip1) and 7 (Trip2), respectively; the wiring method is shown in Fig. 5. When the external shunt switch is on, the circuit breaker will execute the trip command.

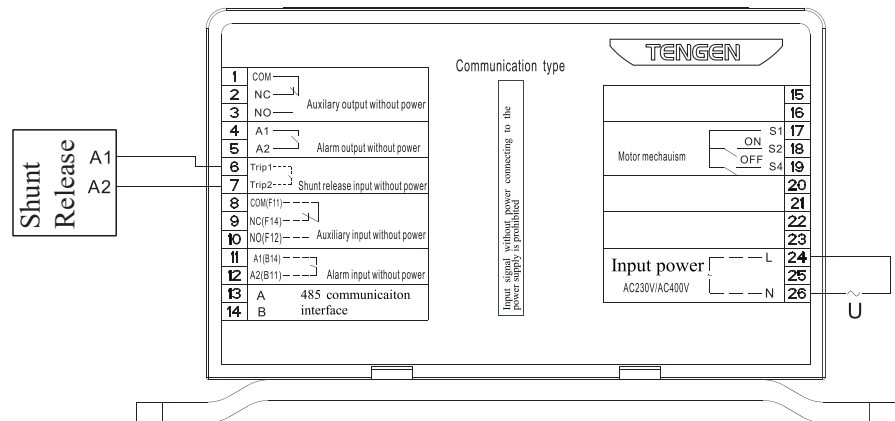

Fig. 5 Shunt and communication module wiring diagram

8.6.3.5 Function area of auxiliary output without power

The function area of auxiliary output without power receives the signal from the function area of auxiliary input without power to indicate the circuit breaker OFF/ON stat. Contact 2 means a NC contact, contact 3 means a NO contact, and contact 1 means a common contact. The ON indicator L2 and OFF indicator L1 are connected externally, as shown in Fig. 3. When the circuit breaker is normally closed, the indicator L2 is lit, and the indicator L1 is off; when the circuit breaker is off, the indicator L2 is off, and the indicator L1 is lit.

TGM1NE Series Moulded Case Circuit Breaker

8.6.3.6 Function area of alarm output without power

The function area of alarm output without power receives the signal from the function area of alarm input without power to indicate the circuit breaker trip state. The alarm indicator L3 is connected externally, as shown in Fig. 4. When the circuit breaker works normally, the indicator L3 is off; when the circuit breaker trips, the indicator L3 is lit.

8.6.3.7 RS485 communication function area

RS485 communication function area provides a communication interface for realizing the connection between the circuit breaker and the APP. The four-remote function of product can be realized through the host computer software by combining with accessories such as motor mechanism and auxiliary alarm: telemetering, telesignalling, telecontrol, and tele-regulation (only for communication type product). To realize this function, this communication module protocol shall be followed.

8.6.3.8 Side plate function area

The reset button Reset can reset the communication parameter function. When the luminous tube is green lit, this indicates normal standby; when it is blue lit, this indicates normal communication (for communication type).

8.6.3.9 Factory default communication parameters

Table 32

Communication protocol	Address	Baud rate	Data bit	Parity bit	Stop bit
Modbus-RTU	10	9600bps	8 bits	Even parity	1

8.6.4 Overload alarm non-trip module function area

8.6.4.1 Description of overload alarm non-trip module (see Fig. 6)

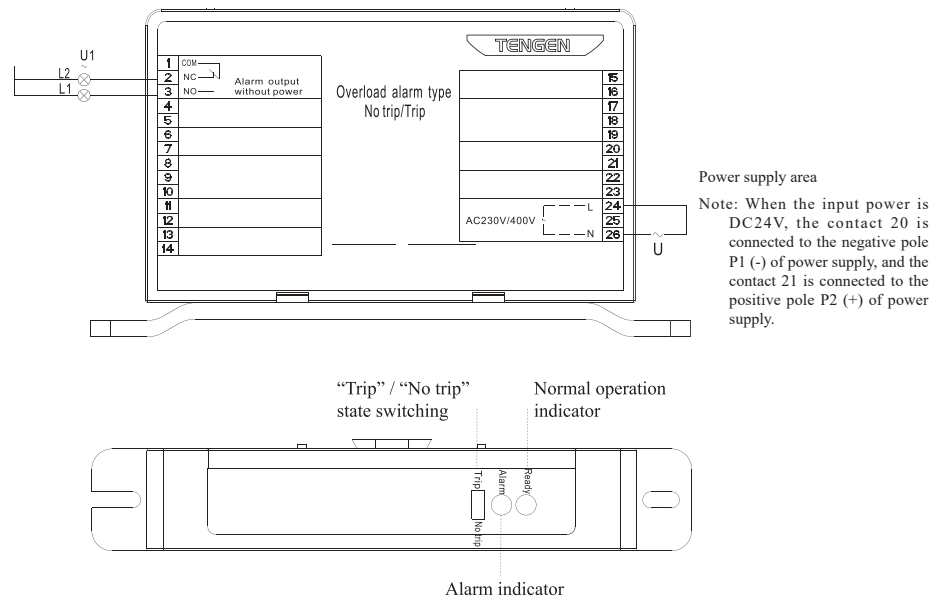

Fig. 6 Description of overload alarm non-trip module

TGM1NE Series Moulded Case Circuit Breaker

8.6.4.2 Function area of alarm output without power

The function area of alarm output without power receives the signal from the body to indicate the circuit breaker alarm state. The contact 2 means a NC contact, the contact 3 means a NO contact, and the contact 1 means a common contact. When the circuit breaker works normally, the indicator L2 is lit and the L1 is off; when an alarm is issued from the circuit breaker, the indicator L2 is off, and the L1 is lit, as shown in Fig. 6.

8.6.4.3 Side plate function area

With the toggle switch function, the alarm trip [Trip] and alarm non-trip [No trip] can be switched, as shown in Fig. 6. When the luminous tube is green lit, this indicates normal standby; when it is red lit, this indicates alarm function.

8.6.5 Operation and With maintenance

8.6.5.1 Inspection and preparation before operation

The following inspections are required before operation:

- 1) Check whether the wiring connection is correct;
- 2) Confirm that all terminal connections are tightened firmly without loose terminal;
- 3) Mark sure that the phase insulation and live parts of product are not short circuited to the earth, and an appropriate distance between the circuit breakers shall be kept;
- 4) Confirm no both AC and DC power input.

8.6.5.2 Trial operation

- 1) Conduct the trial operation after confirming no abnormal situations according to all items specified in Article 8.6.5.1;
- 2) Selection of toggle switch before the shipment of module: Alarm trip (only for overload alarm type);
- 3) After power-on, the Ready indicator in the side plate function area green flashes; after the communication module is connected to circuit breaker, the Com. indicator is blue lit (for communication type);
- 4) After power-on, the Ready indicator in the side plate function area green flashes, and the red indicator is not lit; at this time no any alarm is issued (overload alarm type).

8.6.5.3 With maintenance

Inspection and With maintenance must be conducted by professional technician. To replace the communication module by user, please select the model specified by our company to ensure quality. Our company will bear any consequence caused by selection of other model not specified by our company or by modification without permission. Before With maintenance or With maintenance, please disconnect the connection with the module power supply (including circuit breaker circuit, and main circuit of communication module).

TGM1NE Series Moulded Case Circuit Breaker

9 Outline and Installation Dimensions

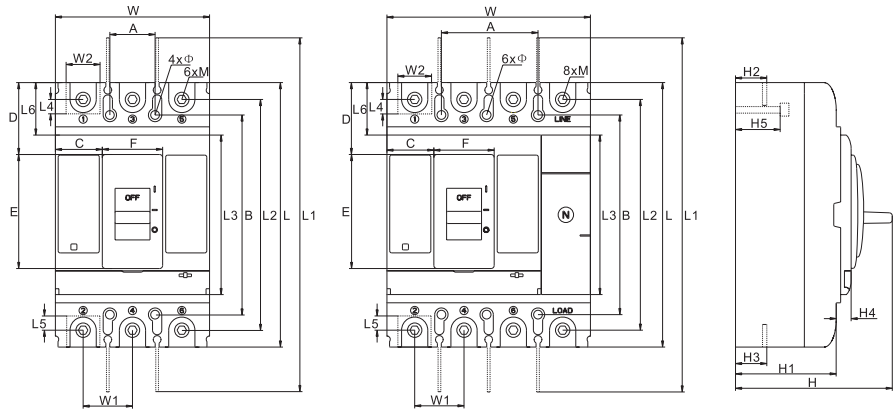

Outline and installation dimensions of product

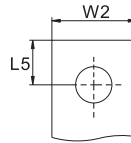

Copper bar insertion length for
100-800 shell frame

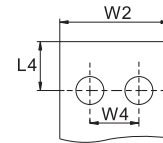

Copper bar insertion length for
1250/1600 shell frame

9.1 Outline dimensions of circuit breaker and size of hole on the panel

Table 33

Product spec.	Number of poles	Outline dimensions (mm)					Installation dimensions (mm)						
		W	L	L1	H	H1	C	D	E	F	L3	L6	H4
TGM1NE-100L TGM1NE-125L TGM1NE-160L	3	93	151	265	99	64	33	41	62	26	98	27.5	12
TGM1NE-100M/H TGM1NE-125M/H TGM1NE-160M/H	3	93	151	265	118	82	33	41	62	26	98	27.5	12
	4	123											
TGM1NE-250M/H TGM1NE-320M/H	3	107	165	300	118	86	39	49	61	29	96	34.5	8.5
	4	142											
TGM1NE-400M/H TGM1NE-630M/H	3	150	257	469	151	98	46	71	110	59	155	51	15
	4	198											
TGM1NE-630 ^M M/H	3	181	270	478	158	103	61.5	81	108	58	161	54.5	14.5
	4	240											
TGM1NE-800M/H	3	212	281	494	160	103	75	83	105	60	176	52	15
	4	282											
TGM1NE-1250M/H	3	210	276	476	150	93	75	81	105	60	176	50	13
	4	280											
TGM1NE-1600M/H	3	210	340	555	195	136	66	115	105	78	210	74	16
	4	280											

TGM1NE Series Moulded Case Circuit Breaker

9.2 Wiring dimensions and installation dimensions of circuit breaker

Table 34

Product spec.	Number of poles	Outline dimensions (mm)									Installation dimensions (mm)			
		H2	H3	W1	W2	L2	L4	L5	M	W4	A	B	φ	H5
TGM1NE-100L TGM1NE-125L TGM1NE-160L	3	25	25	30	18	133	8.5	8.5	M8	/	30	129	5	28
TGM1NE-100M/H TGM1NE-125M/H TGM1NE-160M/H	3	29	29	30	18	133	8.5	8.5	M8	/	30	129	5	28
	4										60			
TGM1NE-250M/H TGM1NE-320M/H	3	22.5	22.5	35	23	145	11.5	11.5	M8	/	35	126	5	60.5
	4										70			
TGM1NE-400M/H	3	39	38	48	33	224	12	11.3	M10	/	44	194	6.5	47
	4										94			
TGM1NE-630M/H	3	40.5	41.5	48	33	224	12	11.3	M10	/	44	194	6.5	47
	4										94			
TGM1NE-630 ^M /H	3	44	43	58	44	235	19	19	M12	/	58	200	7	45
	4										116			
TGM1NE-800M/H	3	41	45	70	45	243	15	13	M12	/	70	243	7	70
	4										140			
TGM1NE-1250M/H	3	28	36	70	46	243.5	13.5	13	M10	21.8	70	243	8	15
	4										140			
TGM1NE-1600M/H	3	41.5	57	70	51.6	310	15.4	15	M10	27	70	303	7	35
	4										140			

10 Circuit Breaker Protection Characteristic Curve

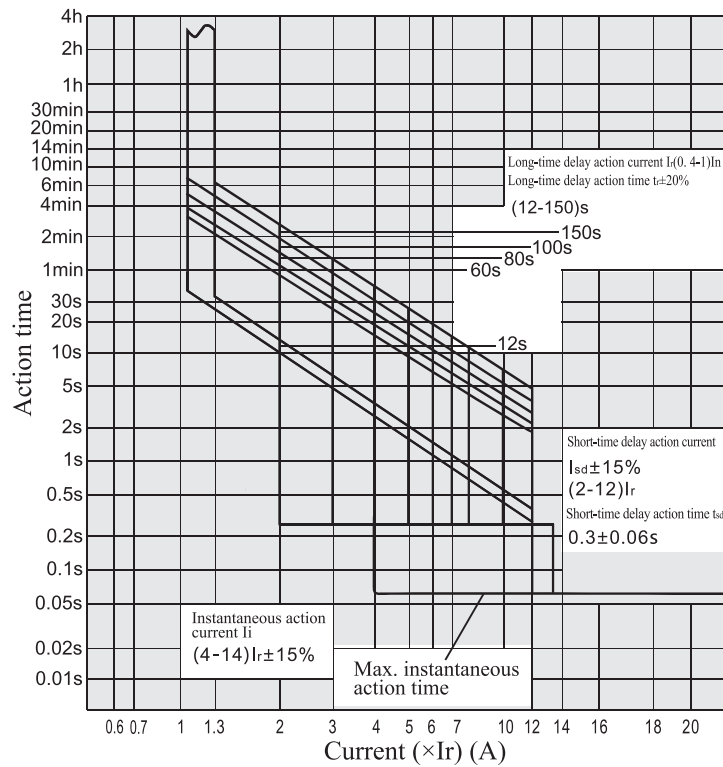

TGM1NE Series Moulded Case Circuit Breaker

11 Factory Settings of Release

Table 35

	Protection type		Distribution protection		Motor protection
	4	Overload long-time delay	Setting current I_r (A)	I_n	
5	Delay t_r (S)		60	100	
6	Short-circuit short-time delay	Setting current I_{sd} (A)	8 I_r		10 I_r
7	Short-circuit instantaneous	Setting current I_i (A)	$I_{nm} \leq 630A$	12 I_r	14 I_r
			$I_{nm} \geq 800A$	10 I_r	
8 (Standard configuration for neutral pole protection, optional for others)	Neutral pole protection (E1)	Setting current I_n	1.0 I_r		
	Grounding protection (E3)	Setting current I_g	1.0 I_n		
	Communication type (E2)	/	/		
9	USB interface				

12 Appearance and Installation Dimensions of Plug-in Products

12.1 Installation dimension of plug-in type after plate

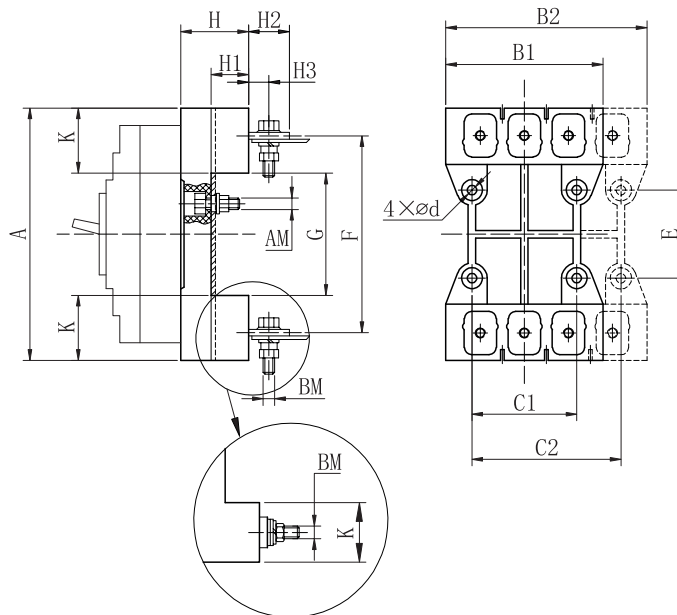

Note: 800 type wiring mode is shown in the figure

TGM1NE Series Moulded Case Circuit Breaker

12.2 Opening size of mounting plate (unit: mm)

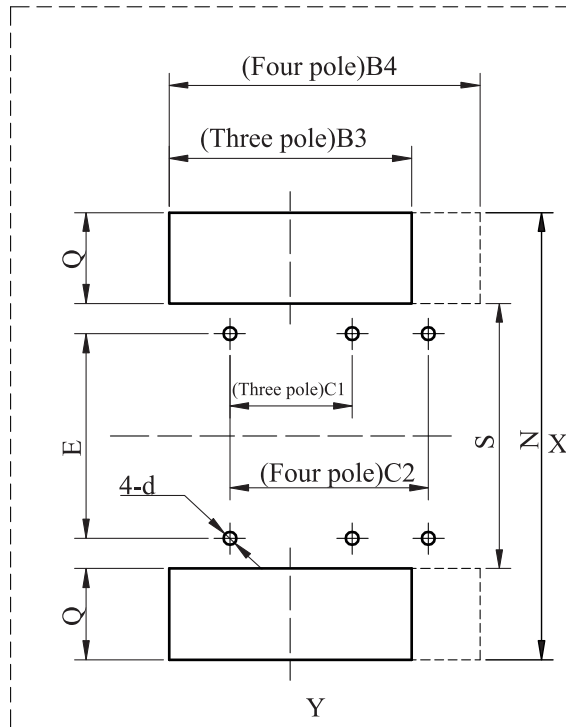

Table 36

Model	Outline and installation dimension (mm)																				
	A	B1	B2	C1	C2	E	F	G	K	H	H1	H2	H3	N	S	Q	B3	B4	AM	BM	4-d
TGM1NE-100 TGM1NE-125 TGM1NE-160	168	91	125	60	90	57	132	92	38	50	33	28	19	178	82	48	101	135	M6	M8	φ6.5
TGM1NE-250	186	107	145	70	105	54	145	94	46	50	33	37	20	196	84	56	117	155	M6	M8	φ6.5
TGM1NE-400 TGM1NE-630	280	149	200	60	108	129	224	170	55	60	38	46	24	290	160	65	159	210	M8	M12	φ8.5
TGM1NE-630 ^S	300	182	242	100	158	123	234	170	65	60	39	50	/	310	160	75	192	252	M8	M12	φ8.5
TGM1NE-800	305	210	280	90	162	146	243	181	62	87	60	22	/	315	171	72	220	290	M10	M14(T)	φ11

TGM1NE Series Moulded Case Circuit Breaker

12.3 Installation dimension of plug-in type in front of the board

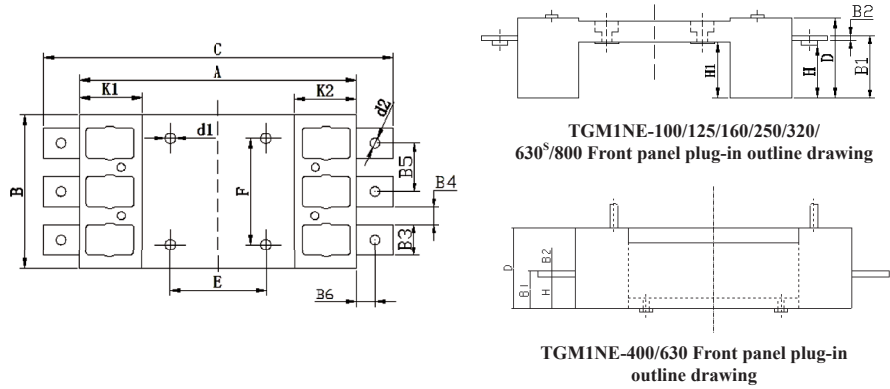

Table 37

Model	Outline and installation dimension (mm)																	
	A	B	C	D	E	F	H	H1	K1	K2	d1	d2	B1	B2	B3	B4	B5	B6
TGM1NE-100 TGM1NE-125 TGM1NE-160	172	95.5	214	50	61	66	12.5	35	38	38	∅7	M8	18	3	19	10.5	30.5	10.5
TGM1NE-250	183	110	259	52	64	70	42	35	44	44	∅7	M10	48	3	22	13	35	22.5
TGM1NE-400 TGM1NE-630	276	150	351	80	135	115	31	/	/	/	∅7	∅11	37	6	25	22.5	48	22
TGM1NE-630 ^S	297	179	397	85	123	100	21	65	64	64	∅8.5	∅13	29	8	35	23	58	34
TGM1NE-800	305	210	409	87	144	90	13	61	62	62	∅11	∅13	21	8	35	35	70	35

13 Ordering Notice

Please specify when ordering: product model, specification, number of poles, accessory, protection feature, rated current, and order quantity.

For example: To order TGM1NE-400, three-pole, circuit breaker with M type breaking capacity for power distribution protection, rated current 400A, 200 pcs.

Specify: TGM1NE-400M/3300 400A (160-400) A adjustable 200 pcs.

For any special requirements (if any) of circuit breaker, please contact the manufacturer for determination through negotiation.

TGM1NE Series Moulded Case Circuit Breaker

14 Product Model

TGM1NE	125	M	Z	4	3	0	2	A	III	E1	125	AC230V	B	Plateau	
Product model	Current section	Breaking capacity type	Operating method	Number of poles	Trip way type	Internal accessories	Usage	Pole N code	Alarm module	Controller code	Rated current	Accessory voltage	Installation method	Application	
TGM1NE moulded case circuit breaker	100: 100A 125: 125A	M: Higher breaking capacity type	Default: Direct operation	3: 3-pole	3: Electronic type	00: No accessory 10: Shunt contact 20: Aux. contact 30: Undervoltage release 40: Shunt + Auxiliary	Default: Power distribution protection	A: Three protective poles, zero line is not disconnected together with other poles	Default: Overload alarm trip	Default: Common four-button controller	100: 32A 63A 100A 125: 32A 63A 125A	AC380/400V AC220/230V DC220V DC110V DC24V	Default: Fixed before-plate	Default: Common application	
	160: 160A 250: 250A	H: High breaking capacity type	Z: Operation by rotary handle	3N:3P+N		50: Shunt + Undervoltage 60: Two sets of auxiliary contacts 70: Undervoltage + Auxiliary 80: Alarm contact	2: Motor protection	B: Three protective poles, zero line is disconnected together with other poles	III: Overload alarm non-trip	E1: Neutral pole protection controller	160: 63A 125A 160A 250: 200A 250A	When there are various accessory voltages, (such as shunt AC230V, undervoltage AC400V)	C: Plug-in back-plate F: Plug-in before-plate	Plateau Moist heat Environmental protection Salt mist Low temperature	
	320: 320A 400: 400A 630: 630A 800: 800A 1250: 1250A 1600: 1600A		P: Motor operation	4: 4-pole		18: Shunt + Alarm 28: Auxiliary + Alarm 38: Undervoltage 48: Shunt + alarm + auxiliary		C: Four protective poles, zero line is disconnected together with other poles		E2: Communication type controller E3: Grounding type controller	320: 200A 250A 320A 400: 300A 315A 400A 630: 400A 500A 630A 800: 630A 800A 1250: 800A 1000A 1250A 1600: 1250A 1600A				